

SprayMaster

Spray Imaging Systems
for
Quantitative Spray Analysis



LAVISION

FOCUS ON IMAGING



SprayMaster is a complete family of imaging systems for state-of-the-art spray characterization. The innovative measurement techniques applied in the SprayMaster systems provide new insights into even complex spray processes and permit cost effective and efficient development of smarter spray systems.

Planar measurements are performed on (laser) light sheets with excellent spatial and temporal resolution. The unique combination of different laser imaging techniques allows multi-parameter measurements with nearly the same system setup.

SprayMaster systems are easy to operate, fast and efficient measurement tools suitable for R&D as well as quality control applications.

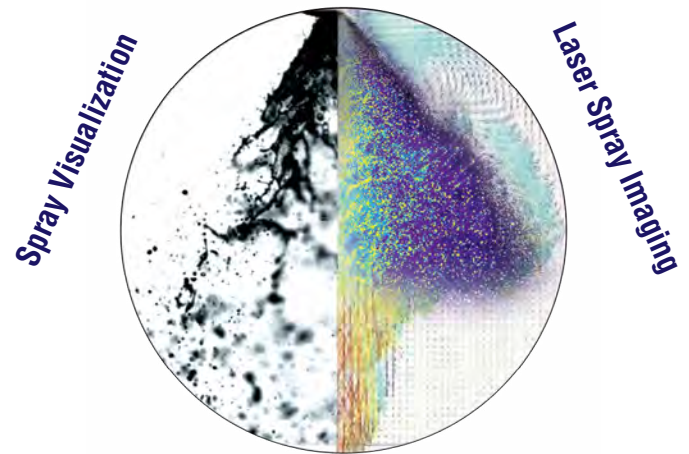

LaVision is committed to their customers. We work in close cooperation with our customers to solve their specific needs with innovative solutions. Integrated turn-key spray imaging systems with unique capabilities are our speciality.

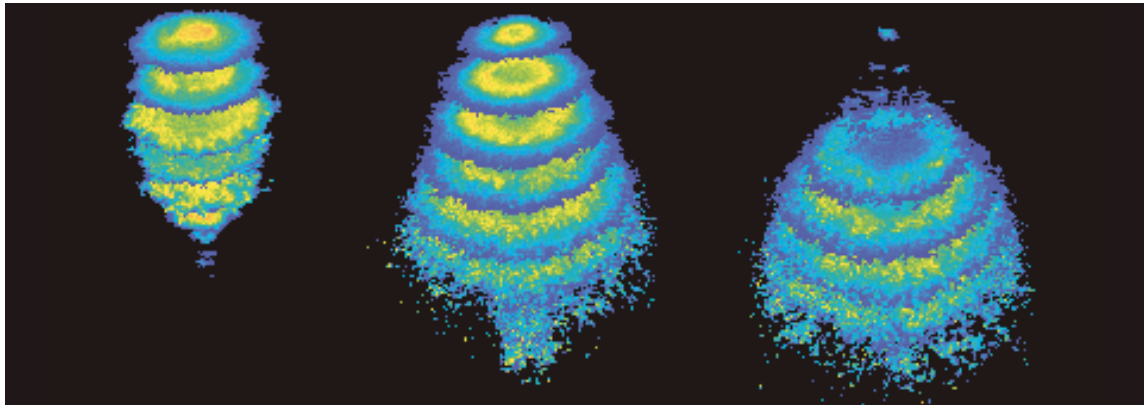

Temporal evolution of a pulsed spray: time sequence of the global spray mass distribution

SprayMaster Applications



Combustion

- ▶ oil burners
- ▶ automotive sprays (diesel and gasoline)
- ▶ gas turbines

Coating and Additives

- ▶ painting
- ▶ insulation and encapsulation

Treatment

- ▶ humidification and misting
- ▶ washing and cleaning
- ▶ fire protection (sprinkler systems)
- ▶ agriculture

Production & Processing

- ▶ drying and cooling
- ▶ foam and dust control



The major task of a spraying application is the conversion of a liquid fluid into fine droplets having a designated size range and distribution. The processes involved are the breakup of the liquid structures into droplets followed by further atomization into smaller droplets. Eventually the fluid may evaporate and mix with the surrounding gas.

This complex multi-stage spray formation process has to be optimized for each desired application. For example, for coating, painting and wetting processes the interaction of the spray with a surface is important, while in combustion spray penetration, evaporation and fuel-air mixing are essential process parameters without generating liquid films on combustion chamber walls.

Spray Visualization Laser Sheet Imaging

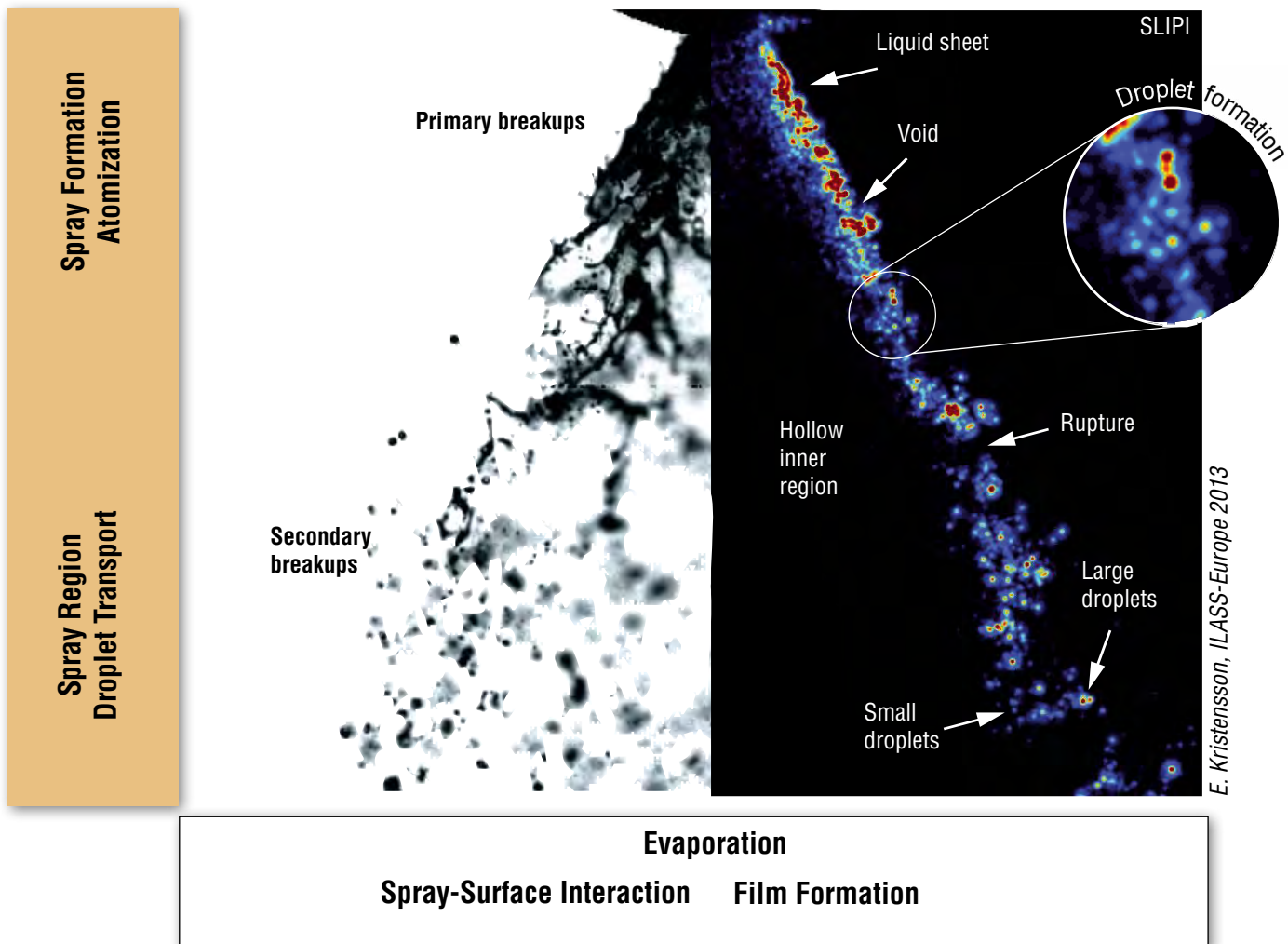

As this spray formation takes place in a millisecond time scale and in a millimeter spatial range, diagnostics for spraying applications require high spatial and temporal resolution without disturbing the spray process. This is best achieved by using optical diagnostics based on laser sheet imaging.

Laser imaging can be applied from macroscopic to microscopic measurements, from qualitative to quantitative spray characterization, from planar to 3D imaging and from single-shot to high speed imaging.

Advantages of laser sheet imaging:

- ▶ instantaneous visualization of (transient) sprays
- ▶ excellent spatial and temporal resolution
- ▶ non-intrusive in-situ spray characterization
- ▶ versatile technology supporting multi-parameter spray measurements



Spray Imaging Overview

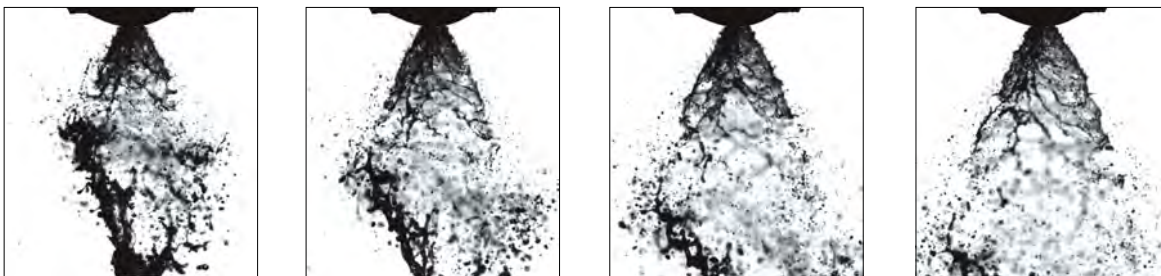
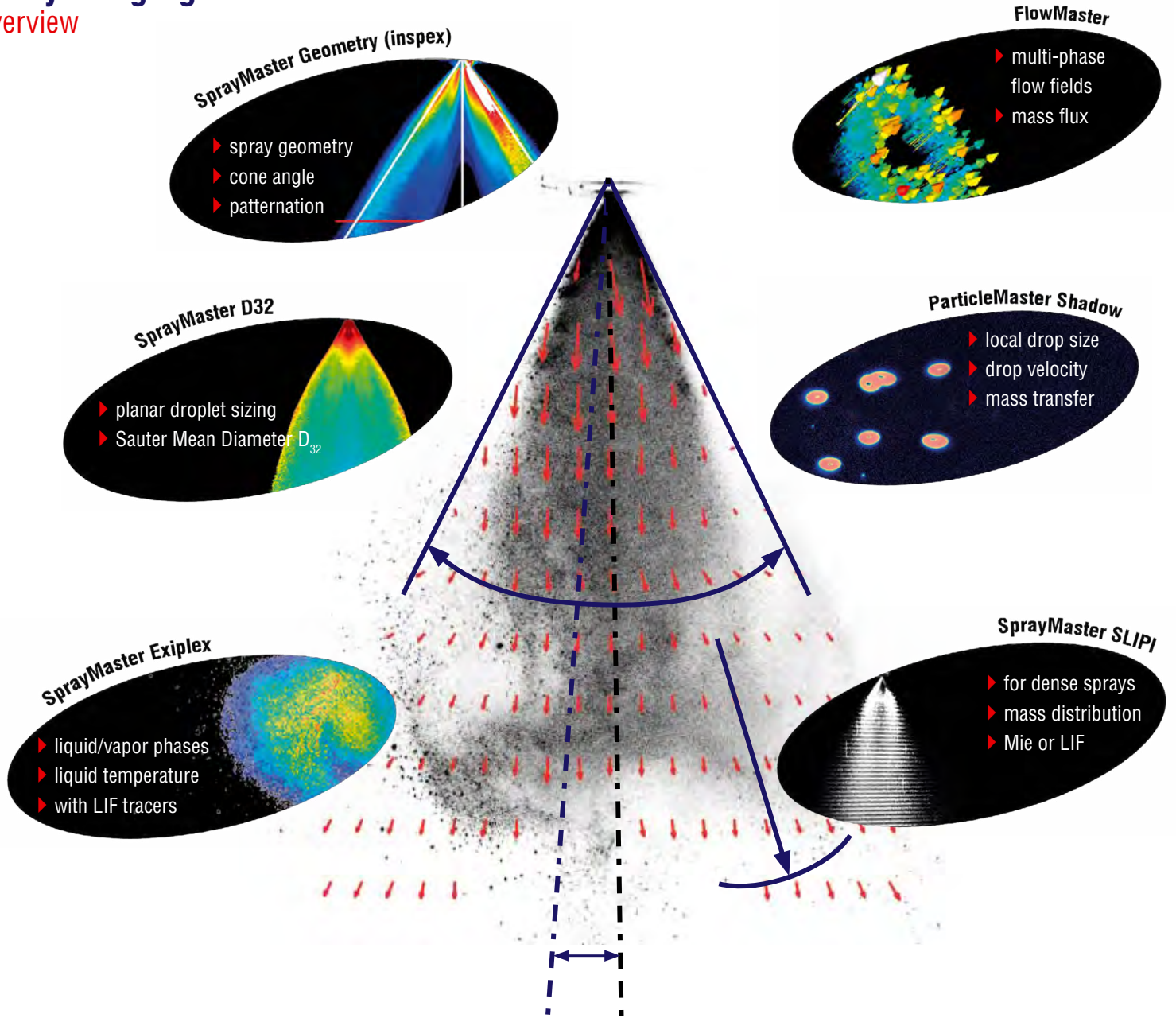

Spray propagation: High Speed imaging at several kHz



LaVision's **SprayMaster** systems enable the user to measure accurate and precise spray data from nearly all types of sprays including continuous sprays, periodic pulsed or transient sprays.

Its **inspex** versions based on backlights or light sheets are designed for routine measurements of spray geometry and patterning. A customized Graphical User Interface (GUI) supporting remote system control is a favorable feature for quality control applications.

SprayMaster systems using laser sheet imaging measure instantaneous liquid (vapor) spray mass distributions and planar droplet size (D_{32}) maps as well as spray flow fields utilizing the PIV technique.

Large scale imaging using extended backlight or sheet illumination as well as high resolution imaging of single μm -droplets are supported.

The accurate timing of (laser) spray imaging is under control of the **SprayMaster** system enabling variable exposure times for continuous sprays, automatic phase scans for periodic sprays and precise high speed recordings for transient spray phenomena.

Structured Laser Illumination Planar Imaging (SLIPI) applying spatially modulated laser sheets is a novel laser imaging technique reducing effectively multiple scattering in dense spray imaging.

SprayMaster main performance features:

- ▶ integrated and modular spray imaging systems
- ▶ comprehensive spray imaging analysis software (**DaVis**)
- ▶ complete hardware control, accurate signal calibration
- ▶ robust system designs for industrial spray testing

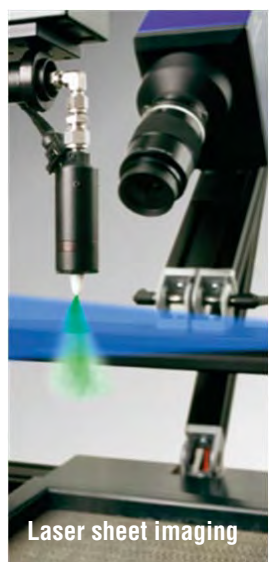

Spray Parameter	Spray Imaging Techniqu(s)	Illumination	Product (Application)
Geometry Shape Patterning	Mie Shadowgraphy Mie	Global-Illumination Back-Illumination Light Sheet	SprayMaster inspex (Quality Control)
Mass Distribution Planar Droplet Sizing Phase Separation	LIF LIF/Mie LIEF	Laser Sheet	SprayMaster (R&D) Geo D32 LIEF
Flow Fields MassFlux	PIV LIF*PIV	Laser Sheet	FlowMaster SprayMaster Flux
Dense Spray Imaging	SLIPI	Structured Laser Sheet	SprayMaster SLIPI
Local Droplet Sizing	Shadowgraphy IMI	Back-Illumination Laser Sheet	ParticleMaster

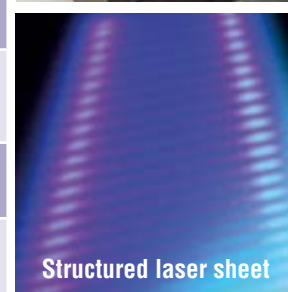

Mie Mie scattering is elastic light scattering caused by surface interaction. The wavelength is not changed. The signal strength is proportional to the surface area of the droplet.

LIF Laser Induced Fluorescence (LIF) is a two step process involving absorption of laser light and subsequent emission at a different wavelength. Thus, its signal scales with the droplet volume or (vapor) mass concentration.

LIEF Phase-sensitive LIF emissions of so called exciplex tracers are used to investigate liquid/vapor transitions and, therefore, evaporation processes in general.

LIF/Mie LIF/Mie image ratios provide planar droplet size distributions in terms of Sauter Mean Diameter (SMD) or D_{32} droplet size maps which have to be calibrated for absolute size information.

LIF*PIV LIF*Mie allows planar mass flux measurements perpendicular to the laser sheet plane.

SLIPI Structured Laser Illumination Planar Imaging (SLIPI) is using spatially modulated laser sheets for Mie or LIF in combination with special image processing routines to reduce the effects of multiple scattering in dense sprays.

Shadow IMI Shadowgraphy and Interferometric Mie Imaging (IMI, applied on laser sheets) measure the size of single droplets in a local probe volume of the spray. Both techniques are used for absolute size calibration of D_{32} size maps.



Contactless optical spray quality control

The **SprayMaster inspex** is a cost effective way of quantitatively measuring the spray pattern in very short measurement times with high reproducibility. It is the ideal testing tool for personal care, beauty & fragrance products, home care and similar sprays.

The number of tested samples per day can be significantly increased by a highly integrated measurement and data generation procedure.

The prealigned setup for a widely adjustable measurement plane reduces setup and product change time to a minimum.

All types of aerosol, non-aerosol and powder sprays, generated from spray pumps or pressurized containers are tested by a contactless optical method simply using a sheet of light.



State of the art objective testing method

The optical spray patterning method is independent of the spray formulation: water, alcohol or oil based liquids, low- and high-viscosity, transparent and opaque, powders, all will be measured with the identical system. Computer based processing of spray images captured by the integrated camera removes any subjectivity arising from a human tester. This guarantees repeatable, operator independent results in a fraction of the time needed by manual or semi-automated testing methods.

The flexible design of the **SprayMaster inspex** system makes it ideally suited for routine spray characterization, from R&D applications through to product quality control and batch testing.

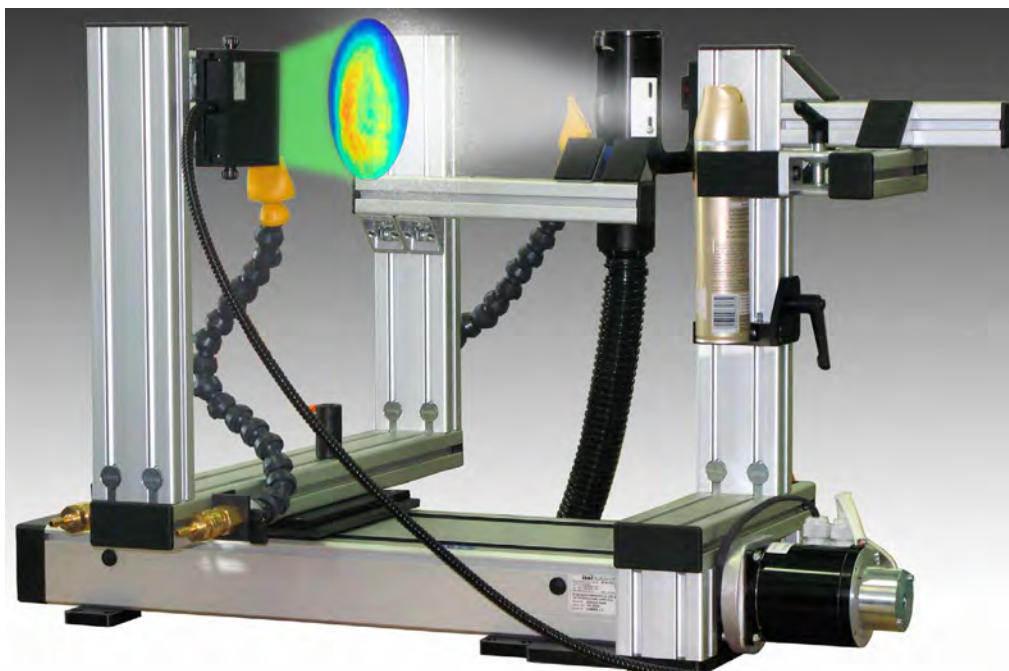
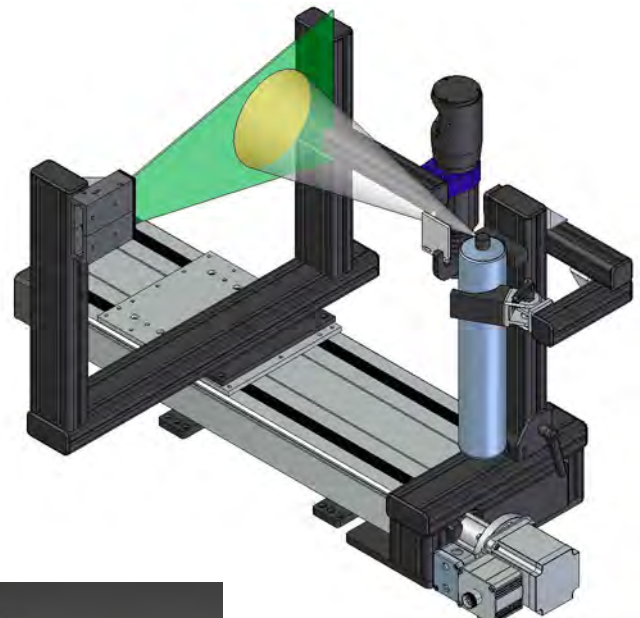



SprayMaster *inspex* components

The **SprayMaster *inspex*** system makes use of flexible optical light guides. The light source is located outside the spray region or testing compartment. This removes any electrical parts of the illumination from the spray.

- ▶ **eye-safe illumination** from flash or LED lamps
- ▶ unique light sheet generation from fiber optics
- ▶ versatile setup

Compact cameras

A choice of compact cameras and lenses provides a small size and fixed setup. Watertight enclosures and protective air purge reduce contamination from the spray product to a minimum.

Optical spray plume analysis

In contrast to paper testing methods, optical spray analysis can take place in the direction of the spray propagation as well.

Either a light sheet will be projected coplanar to the spray plume, or a full field backlight illuminates the projection of the spray plume onto the camera.

Both configurations capture a direct image of the spray cone and measure the cone angle and its main axis direction.

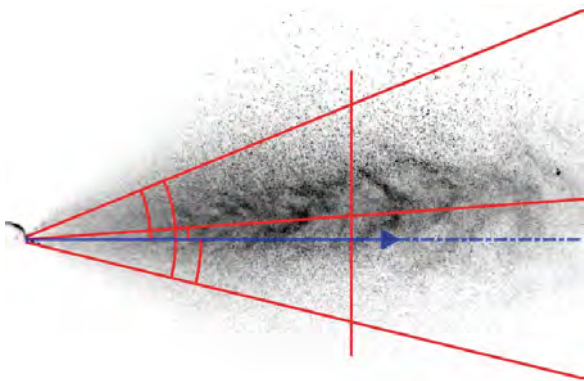

Optical spray pattern analysis

The contactless radial cut of a spray replaces the conventional testing paper or mechanical patterning by a thin sheet of light. The camera captures the intersection of a light sheet with the spray plume at a defined plane and immediately generates a spray pattern image from it.

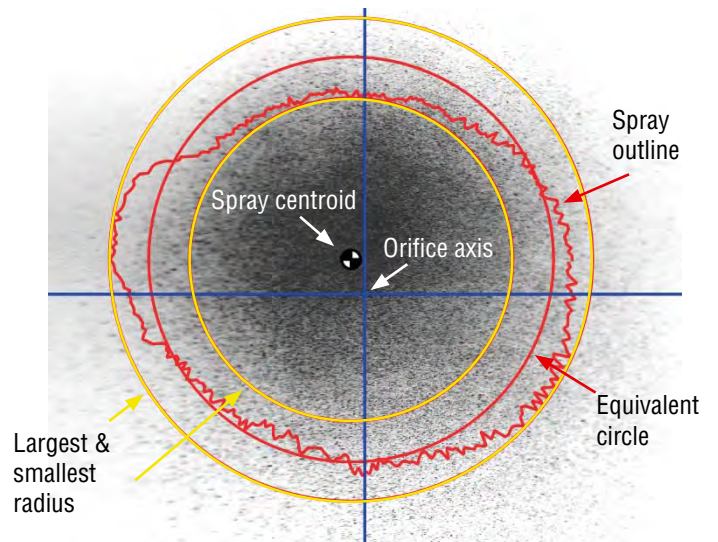

Measured properties of the spray pattern

Spray outline: based on an objective and repeatable automated algorithm

Spray area: total spray area covered by the outlined part of the spray pattern

Centroid: automated detection of the spray center position and its location relative to the mechanical spray axis

Spray diameter: the equivalence diameter represents a circle of the same area as the spray pattern

Circularity: shortest and largest extension of the spray pattern show how good the pattern matches to a circle

Pattern shape: an angular profile of spray density shows the portion of spray propagating into a certain direction and reflects the uniformity of the spray pattern

Time resolved spray evolution

Using fast framing cameras, the **SprayMaster *inspex*** can record the spray stroke in slow motion. This allows a detailed time resolved analysis of every stage of the spray. The very first breakup and the spray end can show a behavior different from the average spray plume, with impact to the overall spray quality.

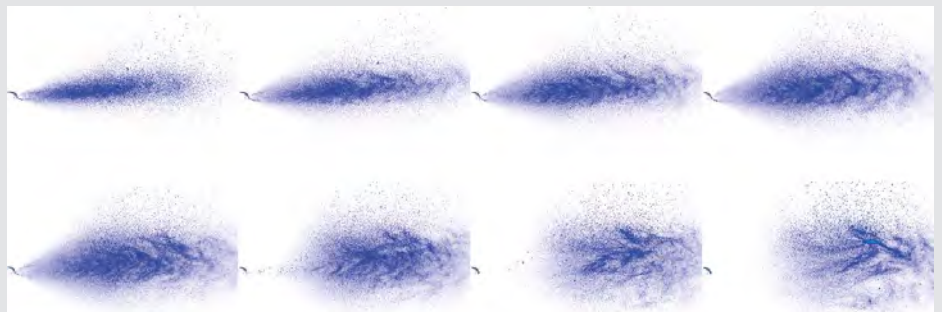



SprayMaster *inspex* for fuel sprays

The **SprayMaster *inspex*** is designed as a universal and easily applicable tool for the measurement of fuel spray geometry.

Spray cone size, shape and evolution is directly imaged either with standard or slow-motion cameras. A fast optical shutter or strobe light illumination freeze any motion and reveals crisp still standing images from any stage of the spray plume development.

The system can be universally applied to all types of fuel sprays, like Diesel, port fuel or direct injection gasoline, or gas turbine injector sprays. Spray test chambers can be equipped with the eye-safe non-laser optical **SprayMaster *inspex*** testing system. Unique optics, designed by LaVision, generates thin light sheets without using lasers. Global illumination is provided by backlighting or flash lights.



Image courtesy of Sonplas GmbH

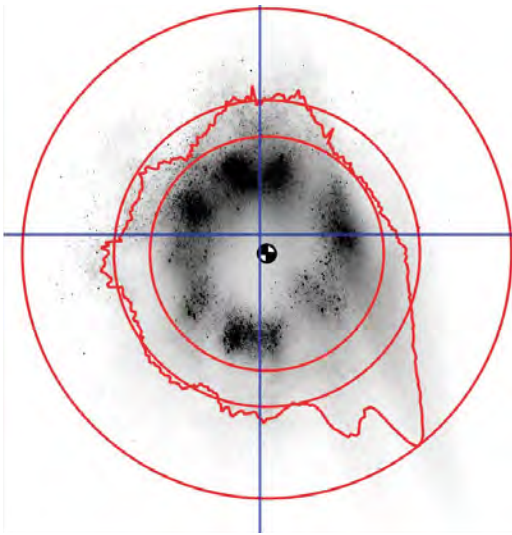

Multi-hole GDI spray pattern with centroid, 50% and 80% mass circle

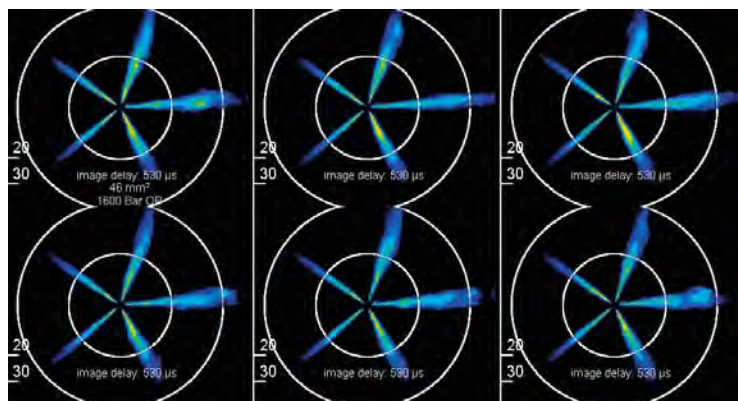
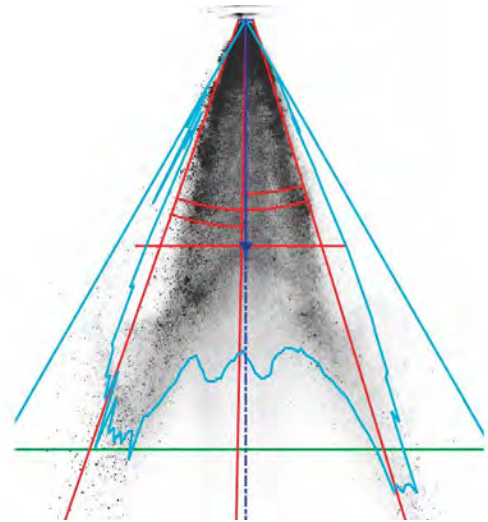

High-speed recording of a Diesel spray

Time-resolved high-speed measurements

A **SprayMaster *inspex*** system based on high-speed cameras and appropriate illumination allows recording multiple spray strokes within a very short time.

In a quality testing environment, high-speed cameras quickly generate return on investment resulting from a large number of tests which can be performed within a short period of time. A few 10 spray strokes are sufficient to capture all information about the spray development with a good statistical relevance.

The benefits of using high-speed cameras are:

- ▶ individual spray strokes are fully **time-resolved**
- ▶ **stability information** about the spray cone development
- ▶ drastically reduced number of spray shots allows a **higher number of investigated** spray conditions
- ▶ **longer operation** time and shorter total setup time due to **reduced contamination** of the spray testing chamber

Axial spray cuts: plume geometry and propagation

Axial cuts are aligned with the spray propagation direction. Measurements are achieved using light sheets, global lighting or backlighting. Spray **cone angles** are measured directly from images using one of these methods:

- ▶ at a given distance from the orifice (single or multiple planes)
- ▶ by interpolation of the spray rim
- ▶ by integration of the spray plume
- ▶ bend angle (deviation from orifice axis) and both half angles indicate the symmetry and direction of the spray plume

Additional measures are:

- ▶ **tip penetration** represents the propagation of the spray, when plotted over time
- ▶ an angular plot shows the **uniformity** of the spray

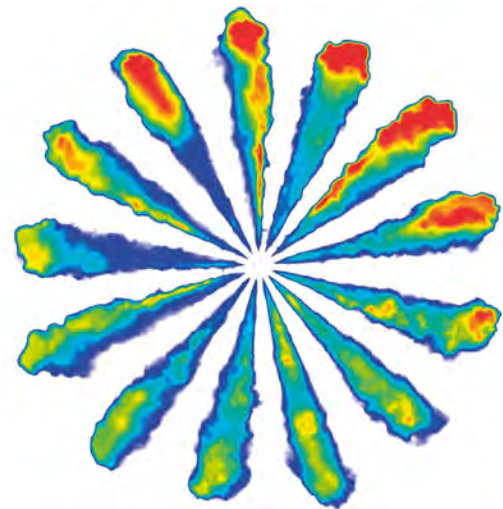

Radial spray cuts: spray patternation

Radial cuts are derived from a light sheet in cross section with the spray axis. The result of this layout is comparable to mechanical patternators. Measured values are:

- ▶ the **spray pattern area** and its equivalent **diameter**
- ▶ **mass circle** diameters according to SAE definition
- ▶ **centroid** position based on spray image intensity
- ▶ largest and shortest **radius** to the pattern rim
- ▶ plots about radial and angular spray distribution reveal the **structural characteristics** of spray plumes

Engine internal spray measurements

LaVision provides optical access to a running engine using endoscopes and illumination probes for the camera and lighting.

The **EngineMaster inspex** is a direct upgrade from a **SprayMaster inspex** to be synchronized and operated on engine test beds.

These systems visualize the fuel spray directly inside the engine with minimum modifications.



Multi-hole injectors

For Diesel injectors and multi-hole gasoline injectors it is necessary to get detailed information about the stability and uniformity of each single spray cone. Time resolved measurements of individual spray strokes allows comparing the shot-to-shot stability.

Each cone of a multihole/multi cone spray is processed individually to present information about uniform spray evolution.

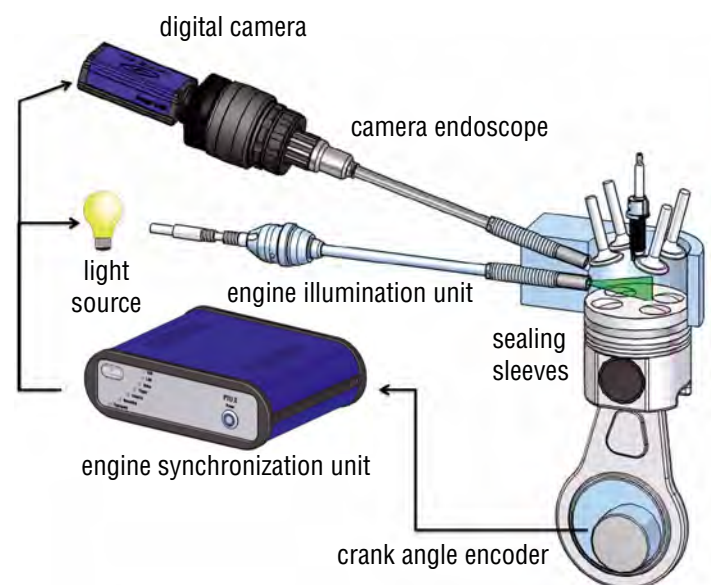



ParticleMaster Shadow

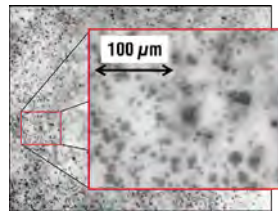
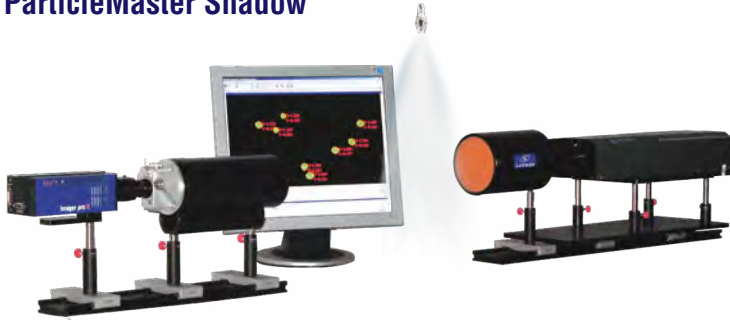

Raw image

Based on imaging shadow projections of droplets the method of Shadowgraphy is applied in a small volume at a desired position within a spray (local). Quantitative absolute results are obtained and a range of light sources from pulsed LEDs to lasers can be used as backlight source. A long distance microscope assures a safe working distance at a high magnification to even detect very small droplets.

- ▶ droplet size and velocity incl. correlations
- ▶ drop shape (eccentricity)
- ▶ statistics, histograms (D_{10} , D_{32} , DV_{50})

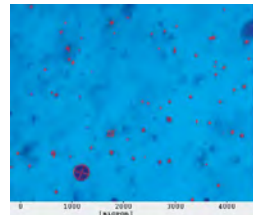

Detected droplets

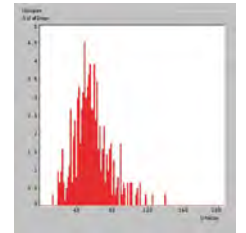

Particle size histogram

ParticleMaster IMI



The approach with interferometric Mie Imaging (IMI) is recommendable for scarce sprays and uses a laser light sheet thus observing a larger area than Shadowgraphy. From defocused imaging in forward scattering direction interference fringe patterns are recorded which contain the information about droplet size in the fringe frequency.

- ▶ droplet size and velocity
- ▶ size/velocity correlation
- ▶ statistics, histograms (D_{10} , D_{32} , DV_{50})



Standard circular fringe patterns

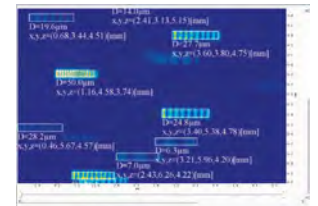

Compressed fringe patterns for denser sprays

SprayMaster D32

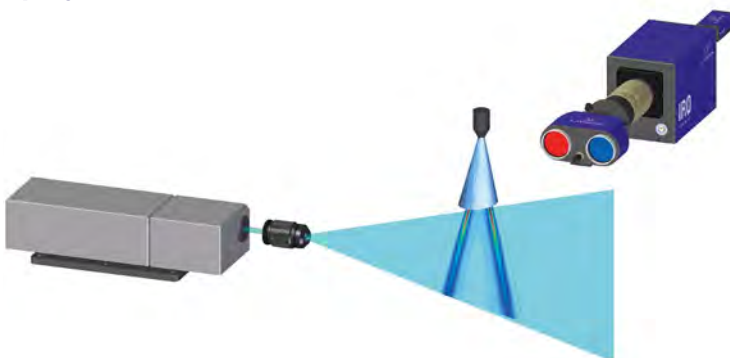

An instantaneous global droplet size map is obtained from the LIF/Mie technique where simultaneously a fluorescence signal (proportional to droplet volume) and a Mie signal (proportional to surface area) are recorded and divided by each other. This gives the Sauter Mean Diameter (D_{32}) from a single laser pulse (fluorescent tracer required).

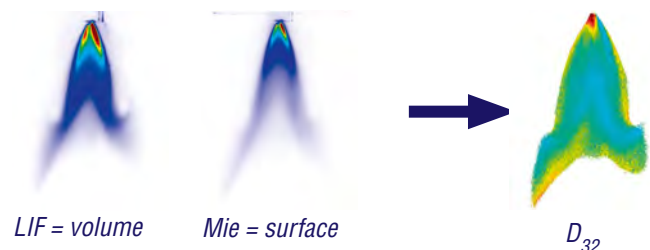

LIF = volume

Mie = surface

D_{32}

SprayMaster LIF

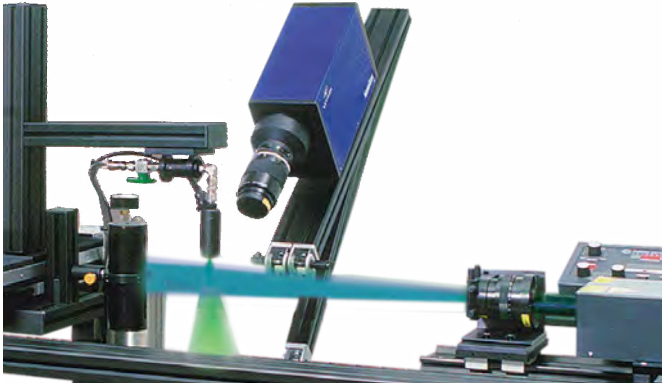

The Laser Induced Fluorescence (LIF) signal is proportional to the droplet mass and, therefore, contains a different information from what can be observed with purely Mie scattered light, which is proportional to the surface of the droplet. In combination with PIV the mass flux can be derived.



SprayMaster Exciplex



Laser Induced Exciplex Fluorescence (LIEF) allows simultaneous visualization of the two phases. Due to the special LIF tracers the signals from the liquid and the vapor phase can be spectrally separated by optical filters.

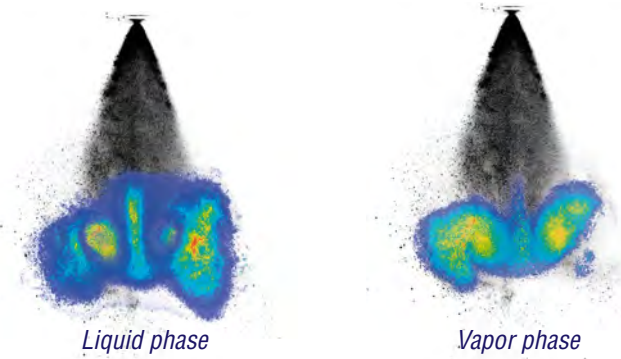

FlowMaster



Velocity field measurements using Particle Image Velocimetry (PIV) are well established in fluid mechanics and can be applied to spray droplets or the surrounding air (with additional seeding). The double-pulse laser of a **FlowMaster** system is an excellent basis for upgrades to many other techniques.

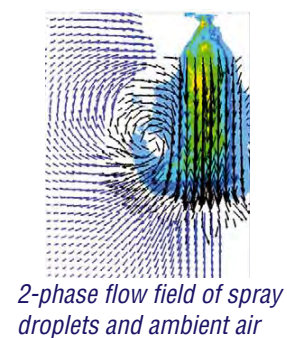

Zhang et al, 2014,
Meas. Sci. Technol. 25 095204



In-cylinder spray imaging

Fuel sprays determine to a large extent the fuel/air mixing process in e. g. IC-engines and gas turbines and, thus, the quality of the combustion process itself. Laser imaging provides useful information about the fuel concentration distribution, evaporation and, finally, maps of fuel/air mixture ratios.



Nowadays laser imaging is a routinely used measurement tool for the investigation of fuel sprays in high pressure test cells or directly inside the combustion chamber. Keyhole imaging can be realized using laser and camera endoscopes, respectively.

Laser spray imaging offers an efficient analytical method for spray characterization replacing old "trial and error" approaches and provides useful data for the validation of CFD models.

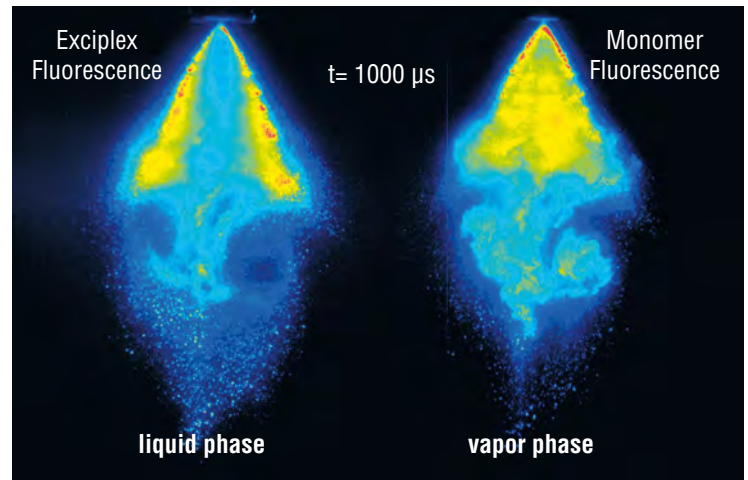
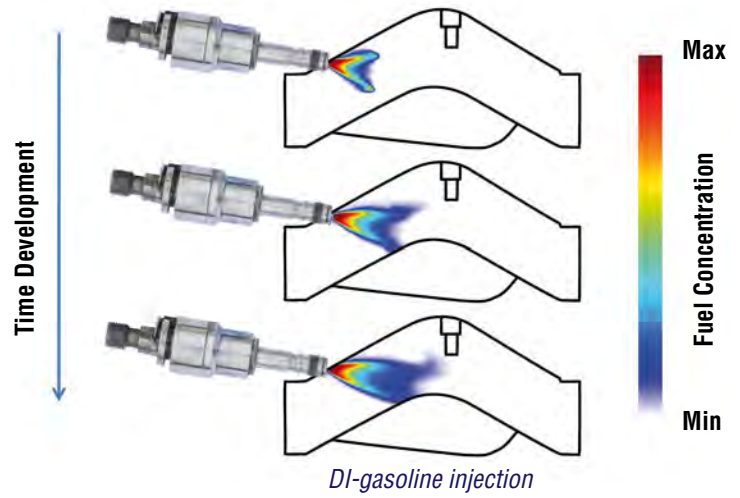
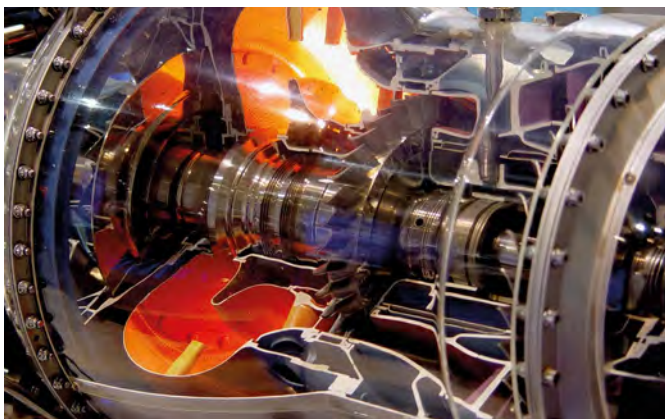

Vaporizing fuel spray

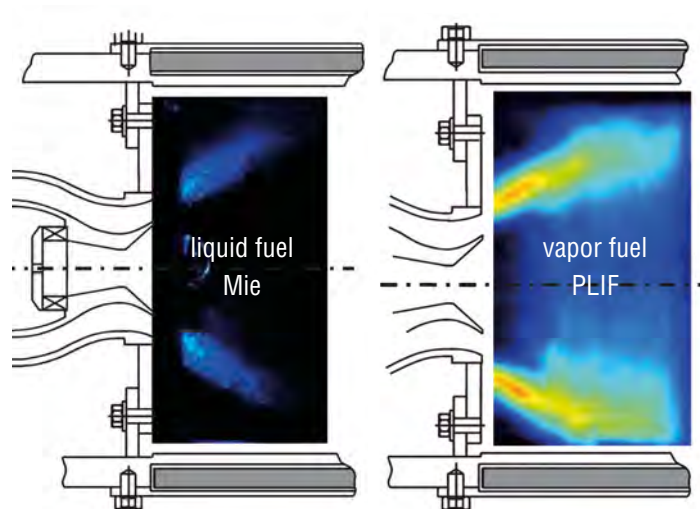

Jet fuel distribution in a gas turbine combustor

Image courtesy of TU-Munich

Novel technique for imaging in dense sprays

Structured Laser Illumination Planar Imaging (SLIPI) reduces multiple light scattering applying laser imaging in dense sprays. SLIPI is based on spatially modulated laser sheets for Mie or LIF imaging. While multiply scattered light loses the modulation information, it is maintained for singly scattered

light. When the stripe-like phase shifted images are combined correctly, the resulting SLIPI image shows higher image contrast and reveals inner spray structures, which are hidden when using conventional planar laser imaging.

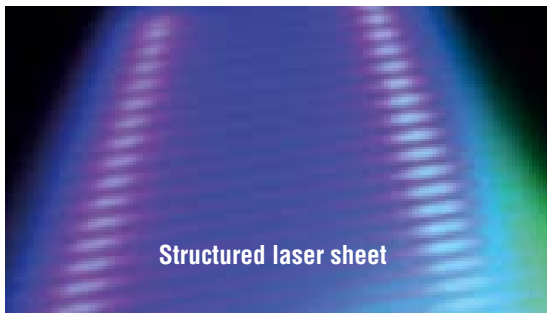

Structured laser sheet

Image courtesy of E. Berrocal and E. Kristensson, Lund University

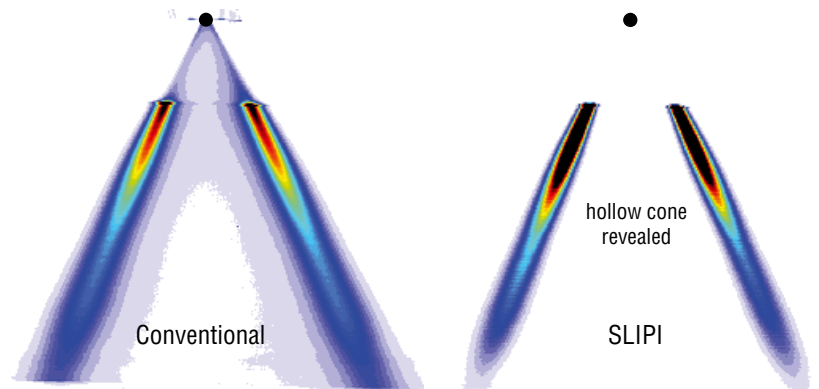

3D spray flow field

Most sprays show turbulent droplet motion and, therefore, are 3-dimensional (3D) in nature. While 2D laser sheet imaging cannot resolve 3D flow structures, tomographic reconstruction techniques using multiple camera views of the illuminated spray volume are capable to capture instantaneously complex spray structures in all three dimensions.

From such time-correlated 3D spray images the instantaneous 3D droplet flow field is derived together with its 3D vortex structure enabling 3D spray characterization in all details.

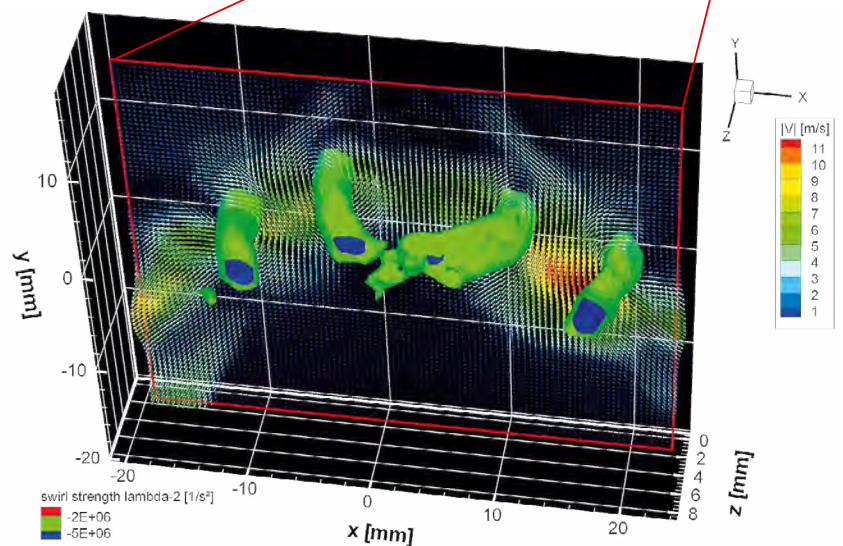
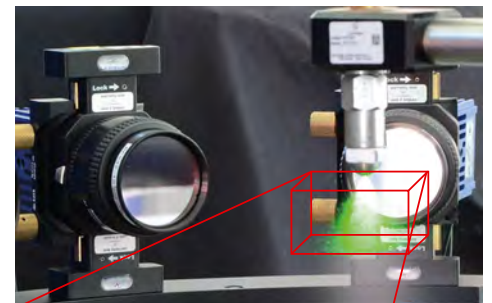



SprayMaster software packages

SprayMaster software packages are designed for a wide range of spray imaging applications, including spray patterning, plume geometry, planar droplet size distribution, and evaporation.

Spray geometry analysis

This basic spray package extracts spray geometry information from back-light and light sheet spray images and replaces conventional patterning by an optical measurement.

Measured values for axial and radial light sheet cuts are:

spray angle at interpolated rim or at a fixed distance, bend angle, tip penetration, front angle, cone diameter, cone symmetry, centroid position, angular and radial profiles of spray density and more.

Analysis of multi-hole injectors (e.g. automotive fuel sprays) reveals individual spray cone information.

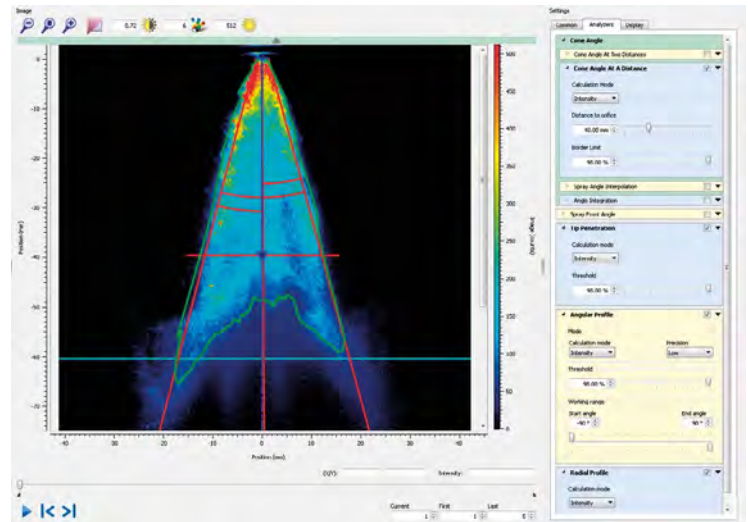

SprayMaster Geometry dialog

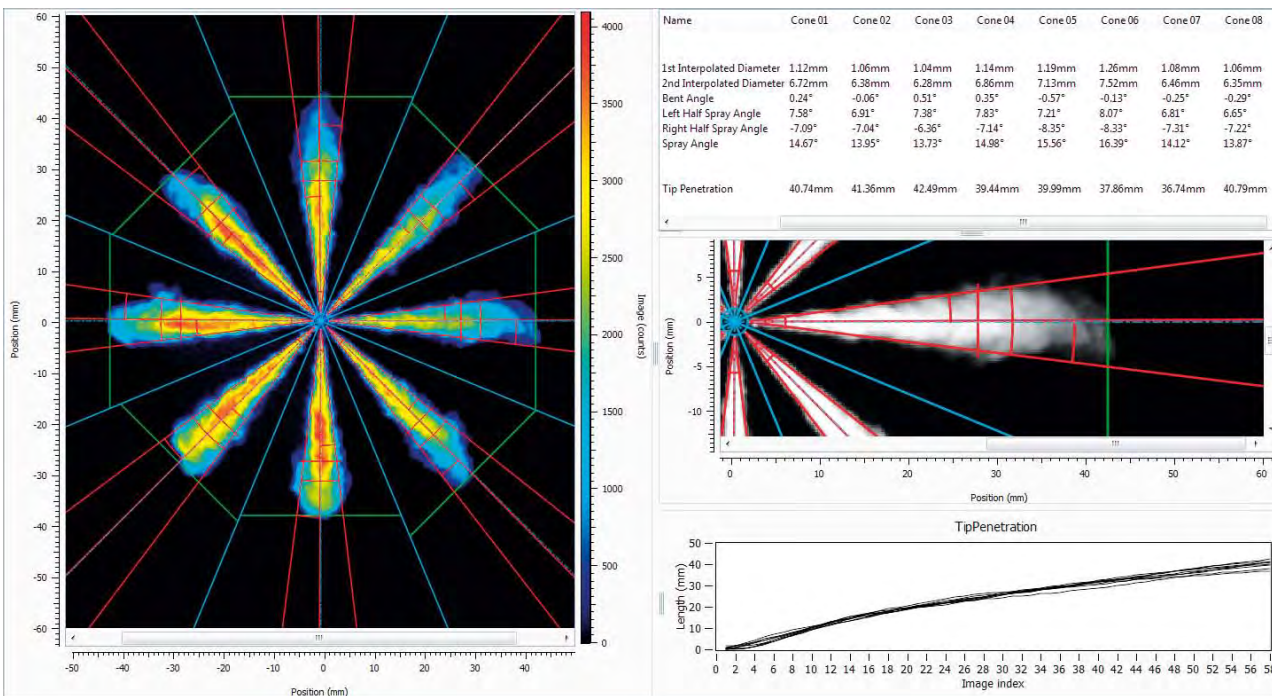

Spray geometry dialog

The **SprayMaster Geometry** package allows to arrange results presentations defined by the operator. Multiple windows can be arranged together in a view according to individual needs. If more space is needed on the screen, information can be spread over multiple tabs. Integrated screenshots and movie generation allow to achieve reportable results with a minimum of user interaction.

Synchronized spray recording

LaVision's unique **Programmable Timing Unit PTU X** allows very flexible triggering and timing schemes for low-speed and high-speed systems. Scanning is the automated variation of the measurement time with respect to the spray injection. The **PTU X** can be triggered by the spray driver system, by a light barrier, or it can generate injection triggers on its own. Multiple injections typical for modern automotive injectors are generated, and the illumination and camera system is automatically synchronized to it.



SprayMaster LIF

The **SprayMaster LIF** package includes all tools to process laser based images. Its main features are:

- ▶ background subtraction removes stray light
- ▶ sheet correction compensates laser sheet inhomogeneities
- ▶ white image correction removes influence of the optics to the image brightness
- ▶ distortion correction and mapping: the so-called de-warping removes any distortion from optics, de-skews images recorded from perspective angles and maps images together from several cameras with sub-pixel precision

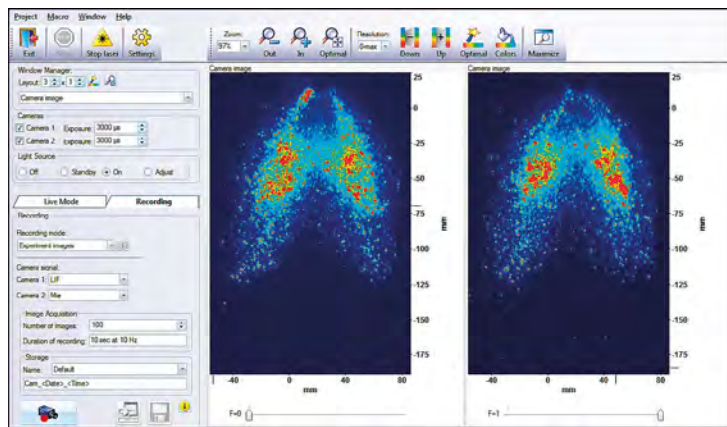
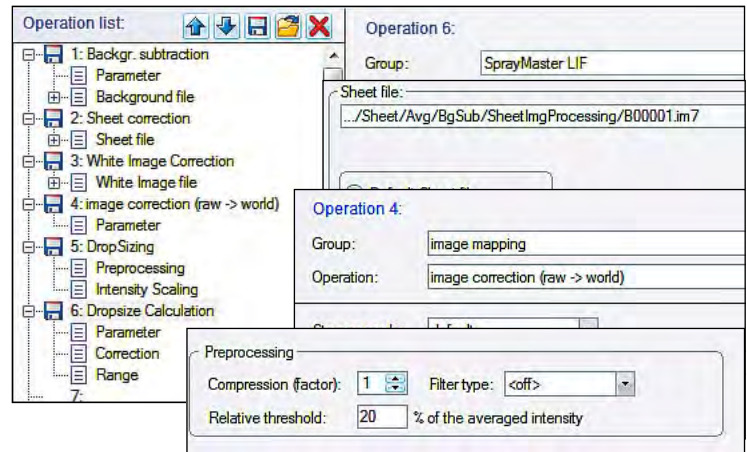

SprayMaster D32

The spatial distribution of the Sauter Mean Diameter (SMD, D_{32}) is measured from planar laser imaging using a ratiometric approach of LIF and Mie scattering. The **SprayMaster D32** package allows to record this information from one or two cameras, matches the images together and reveals a planar D_{32} map.

- ▶ ratiometric approach to calculate global Sauter-Mean-Diameter maps from LIF and Mie image pairs
- ▶ calibration procedure add absolute droplet size using e. g. the **ParticleMaster** systems

SprayMaster Exciplex

Liquid-Vapor separation is obtained by planar laser imaging using Exciplex tracers. The **SprayMaster Exciplex** package supports all image processing steps to separate phase images properly.

- ▶ liquid-vapor separation from Exciplex LIF images
- ▶ removes image cross-talk from overlapping LIF emissions
- ▶ ratiometric approach for liquid/vapor ratio

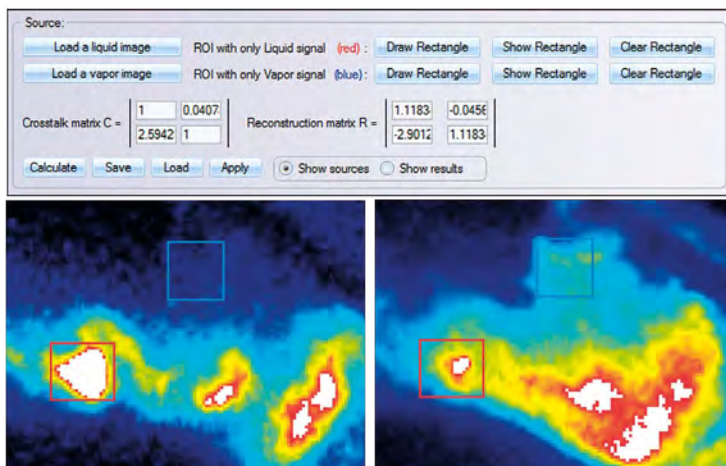

SprayMaster software customization

Based on the standard off-the-shelf functionality, the **SprayMaster** software is the ideal platform to build a highly optimized spray analysis system tailored to your needs. It can be integrated into an existing spray testing environment, e.g. for automated batch testing. Customization of a **SprayMaster** system can be implemented at different levels:

- ▶ optimized user interface
- ▶ streamlined to an existing workflow
- ▶ automated storage of result data, images and reports
- ▶ remote control for automated and unattended operation

LaVision's customized **SprayMaster** systems reduce the operation costs of a spray testing facility and improve the objectivity of measured spray properties. The benefits are:

- ▶ higher testing volume
- ▶ reliable and repeatable results
- ▶ traceability of testing procedures



Related Product Information

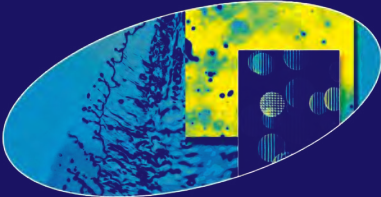

FlowMaster
Advanced PIV / PTV Systems for
Quantitative Flow Field Analysis



ParticleMaster
Intelligent Imaging
for Particle & Droplet Sizing



Focus on Combustion
Optical Measurement Solutions



LaVision Automotive
Innovative Measurement Technologies



LaVisionUK Ltd
2 Minton Place / Victoria Road
Bicester / Oxon / OX26 6QB / United Kingdom
E-Mail: sales@lavisisionuk.com
www.lavisisionuk.com
Phone: +44-(0)-870-997-6532
Fax: +44-(0)-870-762-6252

LaVision GmbH
Anna-Vandenhoeck-Ring 19
D-37081 Göttingen / Germany
E-Mail: info@lavisision.com
www.lavisision.com
Tel.: +49-(0)5 51-9004-0
Fax: +49-(0)551-9004-100

LaVision Inc.
211 W. Michigan Ave. / Suite 100
Ypsilanti, MI 48197 / USA
E-Mail: sales@lavisisioninc.com
www.lavisision.com
Phone: (734) 485 - 0913
Fax: (240) 465 - 4306